



**WALKER HAGOU
MAGNETICS**

CONVEYING SYSTEMS

CONVEYING SYSTEMS FOR

CAN MAKING AND CAN PROCESSING



WALKER MAGNETICS GROUP

ALL OVER THE WORLD

America

WALKER MAGNETICS GROUP, INC.
17 Rockdale St., Worcester, MA 01606
(508) 853-3232, Fax (508) 853-3344

O.S. WALKER COMPANY, INC.
Rockdale St., Worcester, MA 01606
(508) 853-3232, Fax (508) 852-8649
E-mail: info@walkermagnet.com
Web site: www.walkermagnet.com

SALES OFFICE-WESTERN REGION
Chino Hills, CA
(909) 597-4785, Fax (909) 597-0581

WALKER SCIENTIFIC, INC.
Rockdale St., Worcester, MA 01606
(508) 853-3232, Fax (508) 856-9931

SALES OFFICE-MAGNETIC SEPARATION
Milwaukee, WI
(414) 321-9739, Fax (414) 321-9756

WALKER NATIONAL, INC.
811 Kinnear Rd., Columbus OH 43218
(614) 481-0007, Fax (614) 481-0040

WALKER MAGNETICS NATIONAL LTD.
1393 Grahams lane Burlington
Ontario L7S 1W4 Canada
(905) 632-1171, Fax (905) 333-3513

FORD-SMITH MACHINE COMPANY LTD.
675 Arvin Ave., Stoney Creek
Ontario L0R 2L0 Canada
(905) 643-1273, Fax (905) 643-3055

SALES OFFICE-QUEBEC
FORD-SMITH COMPAGNIE, LTE.
3469 Ashby, Ville St. Laurent
Quebec H4R 2K3 Canada
(514) 745-0014, Fax (514) 745-0016

Manufacturing and sales of:

- Lifting magnets
- Magnetic chucks
- Magnetic separation systems
- Scrap handling magnets
- Conveying systems
- Electro magnetic drill stands
- Magnetic mould clamping systems

Manufacturing and sales of:

- Magnetic measuring & analysis instrumentation
- Regulated power supplies
- Electro magnet systems
- Magnet charging & conditioning systems

Manufacturing and sales of:

- Magnets for steel mills to handle
- Scrap • Plates • Slabs
- Bars • Billets • Ingots

Manufacturing and sales of:

- Lifting magnets
- Electric separation magnets

Manufacturing and sales of:

- Heavy duty hydraulic lifting equipment for all types of vehicles

Europe

WALKER-HAGOU MAGNETICS B.V.
P.O. Box 35, 5530 AA Bladel
Industrieweg 9, 5531 AD Bladel The Netherlands
+31(0) 497-383835, Fax +31(0) 497-382006
Dep.conv.systems-Magn.Comp.
Fax. +31(0) 497 384641
E-mail: walker.magnetics@walkerh.nl
www.walkermagnet.com/hagou

WALKER MAGNETICS EUROPE B.V.
P.O. Box 35, 5530 AA Bladel
Industrieweg 9, 5531 AD Bladel The Netherlands
+31 (0) 497-383835, Fax +31(0) 497-382006
E-mail: wme@walkermagnet.com
www.walkermagnet.com/europe

SALES OFFICE-UK
WALKER MAGNETICS UK LTD.
Units 4 & 5 Firbank Court Firbank Way
Leighton Buzzard Bedfordshire LU7 8YJ
(+44) 1 525 372714 Fax (+44) 1 525 375852
E-mail: wmuk@walkermagnet.com
www.walkermagnet.com

BRAILLON MAGNETIQUE, S.A.
Parc d'Activite de la Grande Ile
480 Ave Leonard da Vinci, B.P. 6
73808 Montmelian Cedex, France
(33) 479 84 2145, Fax (33) 479 84 1449

INTERNATIONAL SALES OFFICE
WALKER BRAILLON INTERNATIONAL
Parc d'Activite de la Grande Ile, B.P. 6
73806 Montmelian Cedex, France
(33) 479 84 3040, Fax (33) 479 84 3118
P.O. Box 35, 5530 AA Bladel
Industrieweg 9 5531 AD Bladel The Netherlands
+31(0) 497 383835, Fax +31(0) 497 382006
E-mail: walker.magnetics@walkerh.nl

SALES OFFICE-FILTRATION SYSTEMS C.M.S., S.A.
Parc d'Activite de la Grande Ile
480 Ave Leonard da Vinci, B.P. 6
73806 Montmelian Cedex, France
(33) 479 84 2145, Fax (33) 479 84 1449

WALKER PILANA AS
Nadraznj 804, 76824 Hulin, CZR
(420) 634 328600, Fax (420) 634 351035
E-mail: walker.pilana@prv.czn.cz

Manufacturing and sales of:

- Conveying systems
- Magnetic workholding equipment
- Lifting magnets
- Magnetic material handling systems
- CNC punching machines
- Precision sheet metal working machines
- Magnetic components

Manufacturing and sales of:

- Lifting magnets
- Magnetic workholding equipment
- Magnetic drill stands

Sales of:

- Conveying systems
- Lifting magnets
- Magnetic workholding equipment
- Magnetic drill stands
- Separation systems
- Magnetic components

Manufacturing and sales of:

- Lifting magnets
- Magnetic workholding equipment
- Magnetic drill stands
- Magnetic clutches
- Magnetic tools

International marketing and sales of magnetic devices and systems for the industry

Manufacturing and sales of:

- Water filtration systems

Manufacturing and sales of:

- Lifting magnets
- Magnetic workholding equipment
- Magnetic chucks
- Magnetic tools

Introduction

Walker-Hagou Magnetics is the European headquarters of the Walker Magnetics Group who are world leaders in magnetic technology for over 100 years.

We entered the magnetic conveying market some 40 years ago at the request of customers who were having problems with the then simple magnetic conveyors available at that time.

As magnetic experts, we could see all the errors made by conveyor builders using magnets and as magnet builders making conveyors, we were able to rectify those errors and supply conveying systems that truly worked.

We are the world leader in conveying systems using magnet technology and our products can be found in the major can-makers and can-fillers throughout the world.

A product from Walker-Hagou Magnetics always means value for money.

In this brochure are several examples of the type of products we can offer. If you do not see what you are looking for, it does not mean that we cannot supply it. We are continually making new products to meet our customers ever increasing demands.

Our Sales Offices and engineers are at your service

Walker Magnetics Group
all over the world

Introduction

Can handling equipment
for 2-piece steel cans food and beverage

Can handling equipment
for 2-piece steel cans especially aerosol cans

Can handling equipment
for 3-piece can making

Filling/Packing line
can handling equipment

End handling equipment

Palletizing/Depalletizing equipment

Magnetic components
for can handling equipment

Magnetic sheet separators

Standard elevators / lowerators single

Standard wide belt conveyors
in "built-it-yourself" form, non magnetic

Line control / Services

Walker-Hagou Magnetics products

Addresses sales offices

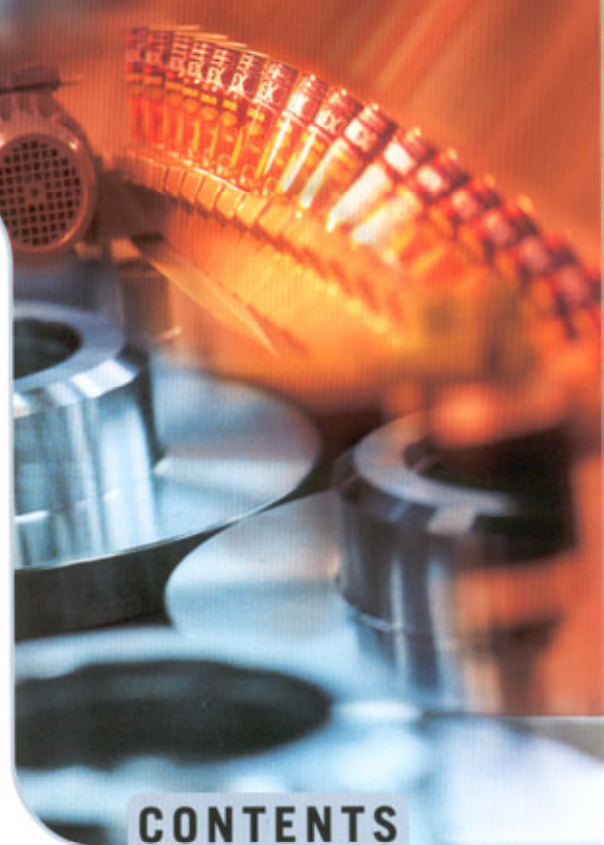

CONTENTS

page 2

page 3

page 4-5-6

page 7

page 8-9

page 10-11

page 12

page 13

page 14

page 15

page 16

page 17

page 18

page 19

backpage

CAN HANDLING EQUIPMENT FOR 2-PIECE STEEL CANS FOOD AND BEVERAGE

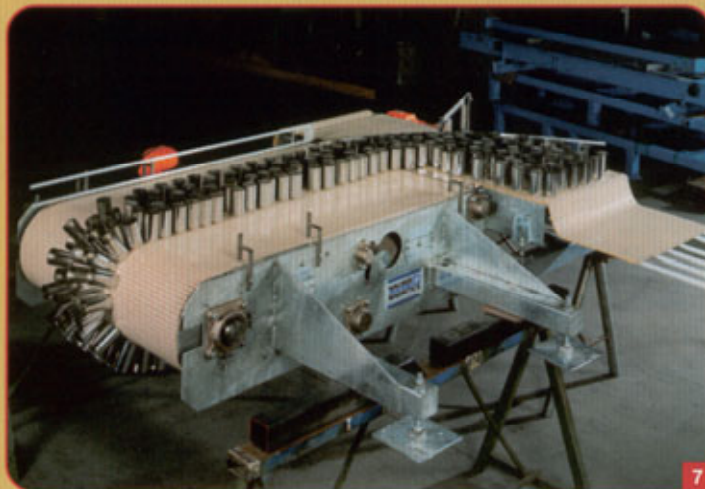
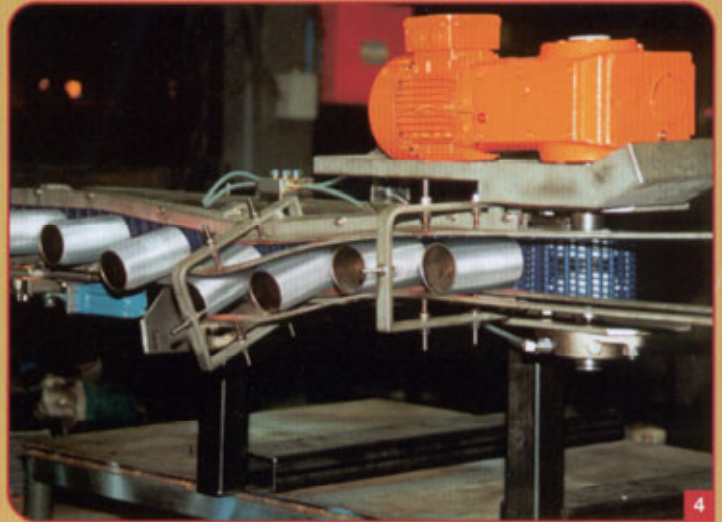
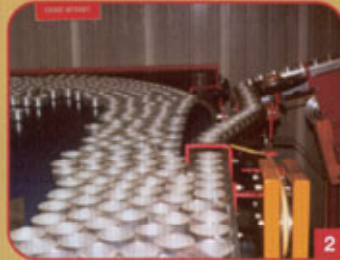

- 1 Copper Discharge elevator
- 2 Copper Discharge conveyor
- 3 Mass mat conveyor
- 4 Bodymaker/trimmer conveyor with coolant recovery
- 5 Trimmer elevator
- 6 Mass conveyor to washer infeed
- 7 Turnover unit to washer infeed
- 8 Magnets for washer transfer

9 Washer Discharge conveyor

10 Mass mat conveyor

11 Camera inspection conveyor

12 Coaters Discharge to M.O.L.

13 Can dividing system one lane to two lanes

14 Decorater discharge to M.O.L.

15 Pin Stripper

16 OBO Discharge elevator with or without fallen can eliminator

17 High speed single elevator behind necker-flanger tester

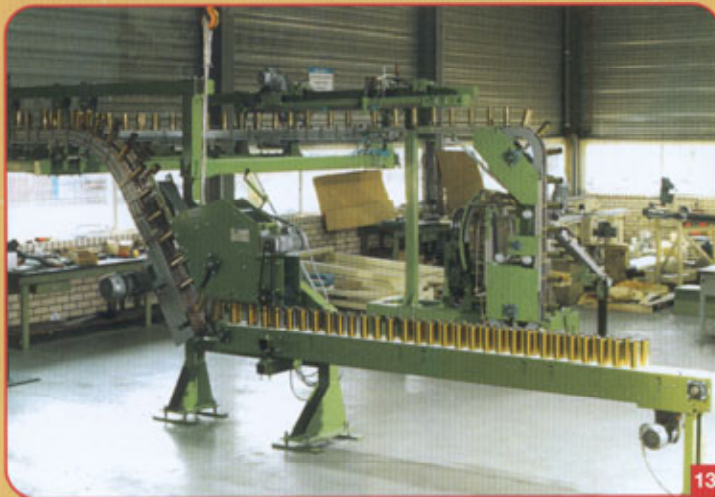

Can handling equipment for 2-piece steel cans food and beverage



18

18 Spray Discharge

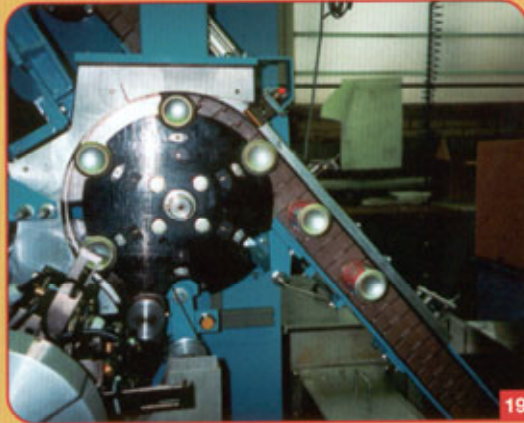

19

19 Bottom Spray
Discharge



20

20 IDT conveyor

21 Camera inspection
conveyor



21

22 Mass Mat conveyor



22

23 Fallen can elimination
conveyor

24 Elevator - lowerator
with or without fallen
can eliminator



23



24

CAN HANDLING EQUIPMENT

FOR 2-PIECE STEEL CANS ESPECIALLY AEROSOL CANS

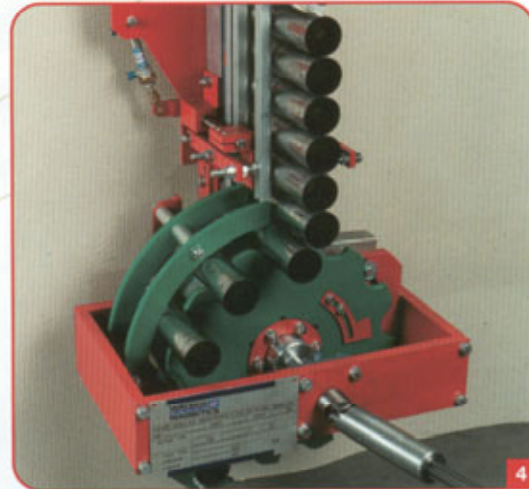
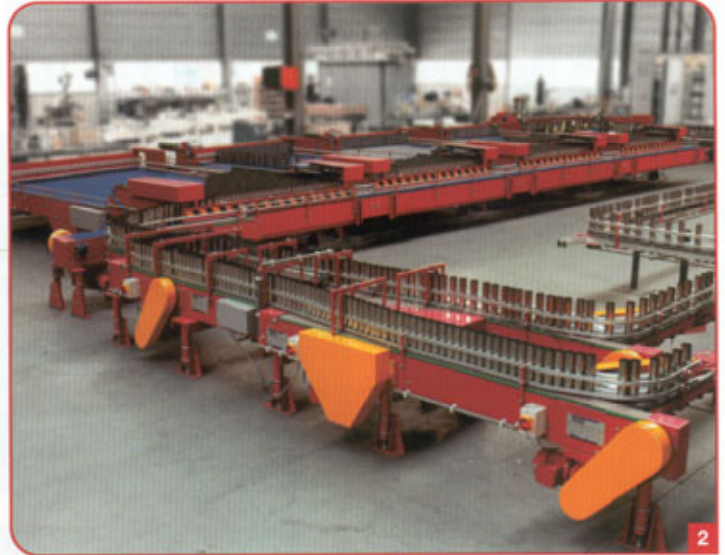

- 1 Magnetically supported**
- cable tracks
 - chain conveyors
 - mat conveyors

- 2 Magnetically supported accumulation systems**

- 3 Magnetically supported inliners**

- 4 Integrated and positive driven in- and outfeed systems for machinery**

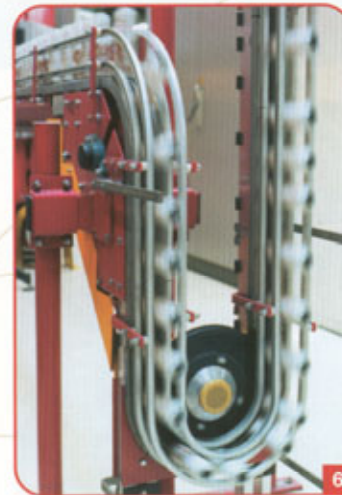

- 5 Magnetic overhead conveyor, height adjustable:**
- automatic
 - hand operated

- 6 Magnetic elevators/lowerators**

CAN HANDLING EQUIPMENT FOR 3-PIECE CAN MAKING



1 Forklift truck magnets



2 Sheet separators for sheet feeders



3 Acceleration conveyor behind welder with magnetic twist upender

4^{AB} Can upenders

5 Magnetic elevator

6 Cable conveyors steel/synthetic cable

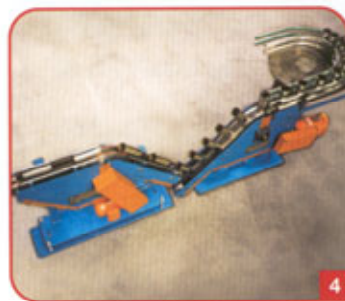

4

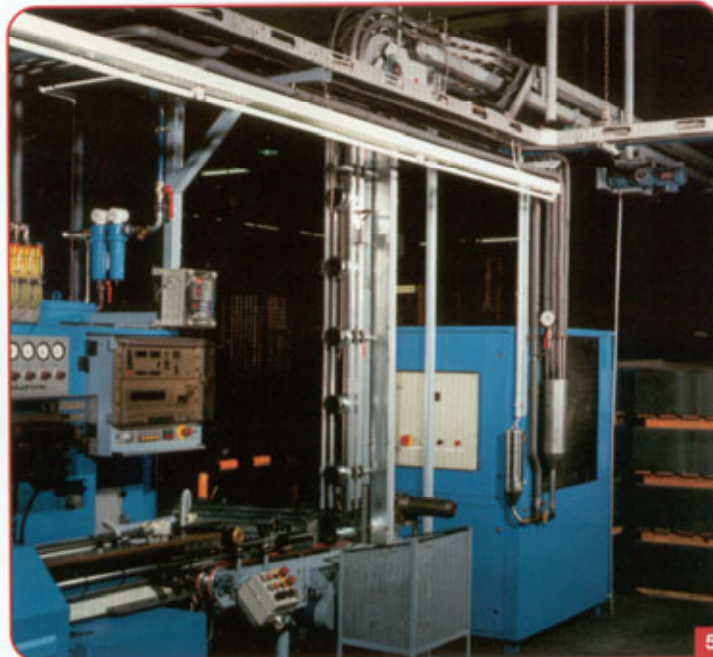

5



6



4A



7

7 Belt conveyors

8 Chain conveyors

- Simplex
- Duplex
- Honed



4B



8



9

9 Slat chain conveyors

- Table top
- Flexitop

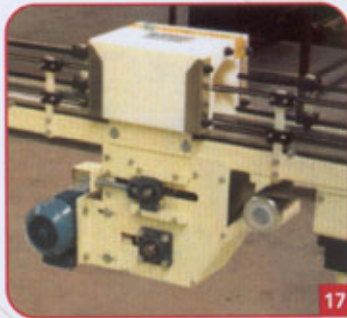
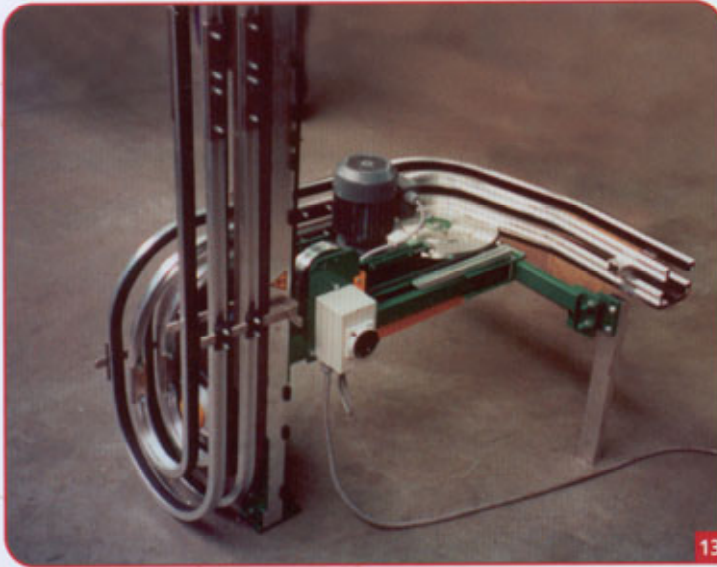
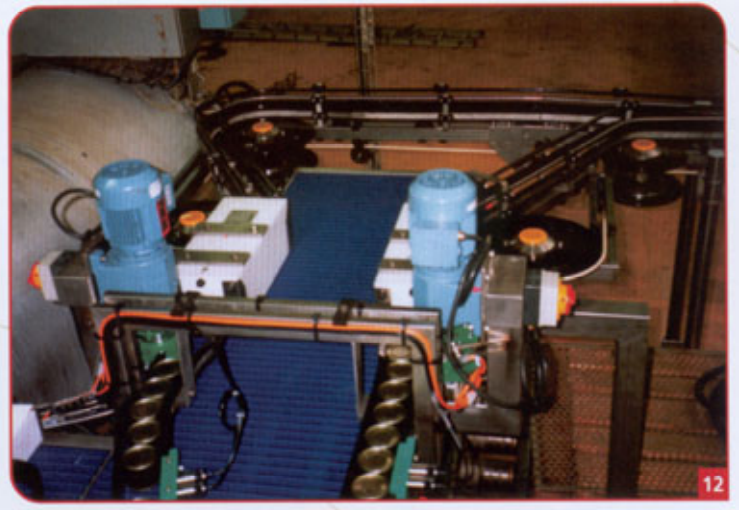
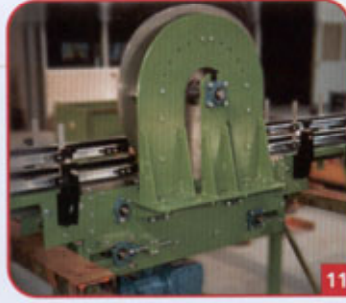
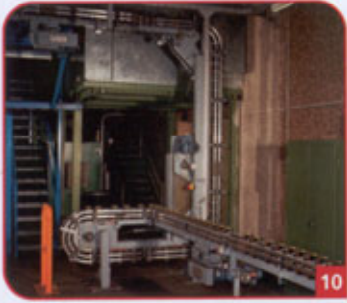

10 Magnetic lowerator

11 Can turn station 180°

12 Metering system

13 Machine discharge conveyor combined with elevator

14 Can twist 90-180°

15 Can turn-over unit

16 Height adjustable pick up point behind discharges

17 Twist blocks

18 Machine integration systems

19 Magnetic down-stacker to avoid scratching of ends

20 Operator control station

FILLING/PACKING LINE CAN HANDLING EQUIPMENT

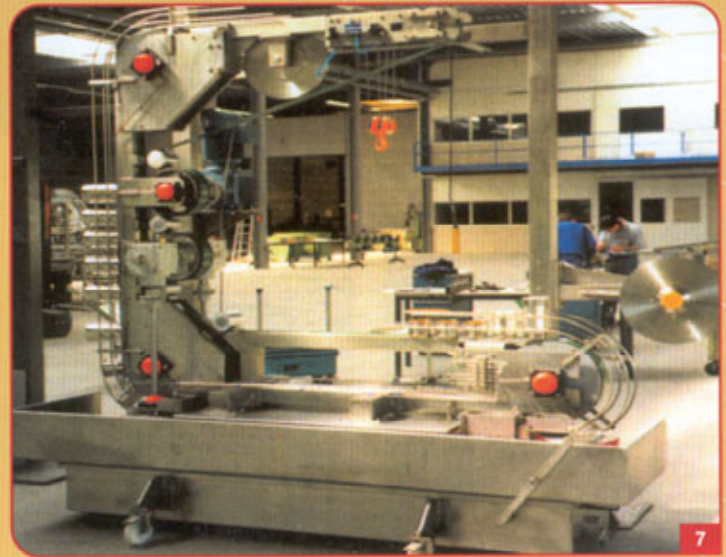
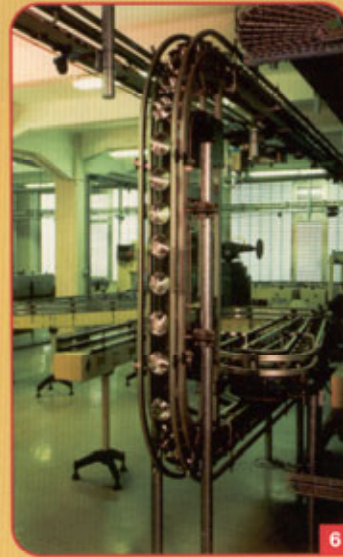

- 1 Magnetic down-stacker to avoid scratching of ends
- 2 Mass conveyors for empty and filled cans
- 3 Can accumulation systems
 - 3A
 - Bi-Di tables
 - Closed loop tables
 - Dividing tables
- 4A Pressureless single liner
- 4B Single liner
- 5 Elevators/lowerators for empty cans
- 6 Elevators/lowerators
 - Cable conveyors
 - Chain conveyors
 - Belt conveyors
 - Mat conveyors
- 7 Lowerator combined with can cleaning systems for empty cans

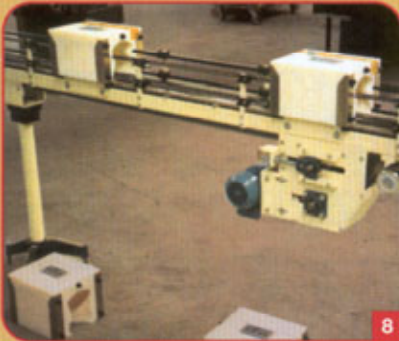

8 Twist blocks

9 Can demagnetizer



10 Cron Cork feeding system



11 Turn-over units

12 End feeding system

13 Elevators/lowerators for filled cans





14 Cap feeding systems

15 Double cable conveyor for trays





END HANDLING EQUIPMENT



Equipment for:

-  ♦ Normal round can ends all steel
-  ♦ Round can ends with aluminium tagger, penney lever, tagger foil, etc.
-  ♦ Easy opening ends

-  ♦ Oval can ends

-  ♦ Square can ends

-  ♦ Rectangular can ends

-  ♦ Top and domes for aerosol cans
-  ♦ A.M. ends
-  ♦ All types of rings

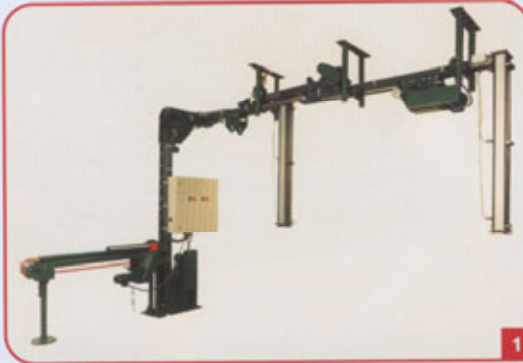

1 End feeding system with downstacker

2 Upstack wheels/ Downstack wheels

3 Magnetic separation system

4 Magnetic downstackers

5 Curved downstackers

- magnetic
- non magnetic

6 Magnetic end handling systems for testing purposes 1200 C.P.M.

7 End bagging system handoperated

8 Magnetic downstacker for rectangular ends

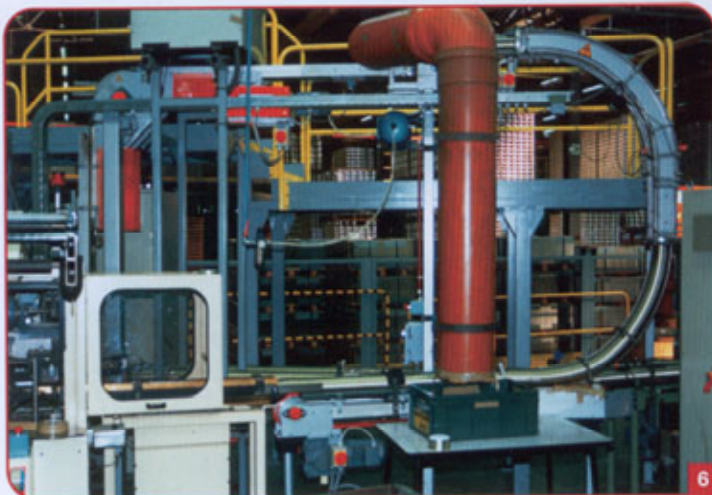
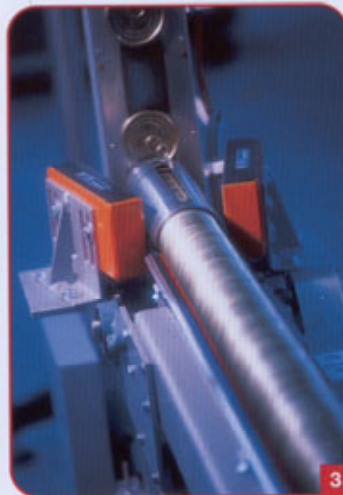

PALLETIZING/DEPALLETIZING EQUIPMENT

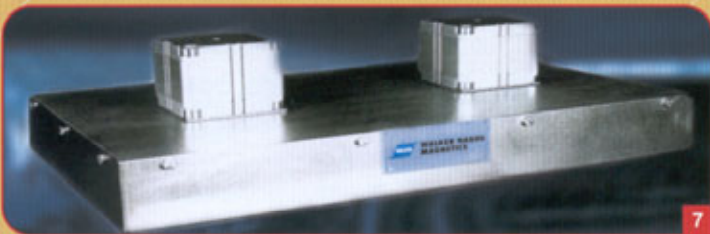
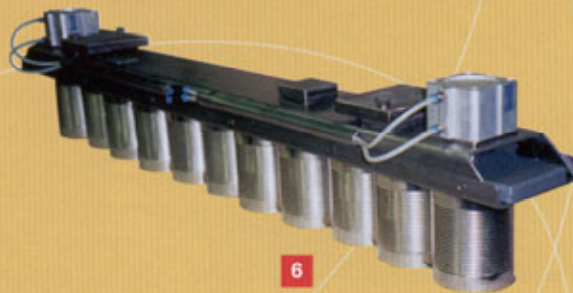
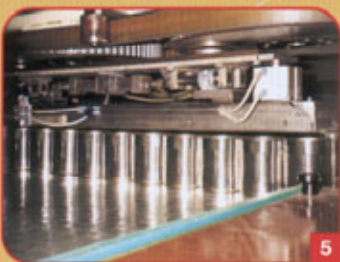

1 Palletizing/Depalletizing magnets for:

- Empty cans
- Filled cans
- Glass jars with steel caps

3 Palletizing/Depalletizing magnets for:

- Empty / Filled cans
- Glass jars with steel caps. For robotics and Pick and Place units extra light weight construction

5 Palletizing/Depalletizing magnets for:

"in line" systems

7 Handling magnets for several steel products f.i. bakery trays

8 Manipulator magnets
Manually operated magnet palletizing/depalletizing head for various applications. Standard size 300 x 380 mm. Code no.530 90 02 Also suitable in combination with a balancer. Also available with pneumatic on/off switching magnet force.

9 Magnets for robotic application
Besides big units for palletizing and depalletizing Walker produce a number of specials which can be used in robotic systems. Magnets for application are customer designed in a lightweight construction.

MAGNETIC COMPONENTS FOR CAN HANDLING EQUIPMENT



Magnetic rollers Ø 220 Ø 400 Ø 600 mm

Several types of magnetic rollers for can conveying systems are produced by Walker. The standard diameters are: Ø 220, Ø 400 and Ø 600 mm.

This range covers most of the requirements for modern can handling. For special applications we produce tailor-made rollers according to customer's requirements.



Magnetic wide size rollers

As part of our mass conveying program Walker produce magnetic rollers in two diameters, Ø 220 mm and Ø 400 mm.

These are available in any width and rollers of 2500 mm long are in regular production.

All of Walker rollers are built to complement Walker plates, thus ensuring a good flow.



Standard magnetic bars

Walker supply magnetic units with a variety of strengths and designs which if chosen correctly will solve most magnetic conveying problems.

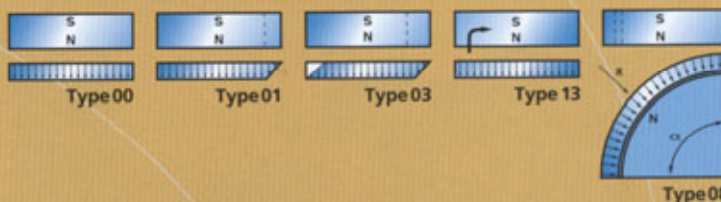

Available in any size with tapered end and/or weakening field

Magnetic plates, magnetic curves

A wide range of magnetic plates are available especially designed for mass conveying such as elevators, lowerators and transfer units. These plates can be used with various types of conveying mediums to transport a wide variety of components, ranging from empty cans to heavy trays used in the bakery industry.

Shapes

Magnetic plates are available in:

- ♦ straight plates
- ♦ curved plates with magnetic field at the inside or outside radius.

Strength

The strength of the magnetic plate is determined by thickness and composition of the magnets.

Special magnets, some examples

1) CABLE CONVEYING

Magnetic components including cable guiding in steel execution. If required, synthetic guiding is possible.

2) CHAIN CONVEYING

Table top chain straight running

Flex top chain with tab

Magnetic components including hinge guiding or tab guiding. These components are available for:

- ♦ straight sections
- ♦ curved sections horizontal and vertical
- ♦ curved sections with positive and negative curve.

3) MAT CONVEYING

These components are similar to standard belt conveyor magnets, but due to the larger air gap caused by the mat thickness, Walker manufacture them with a higher magnetic field.

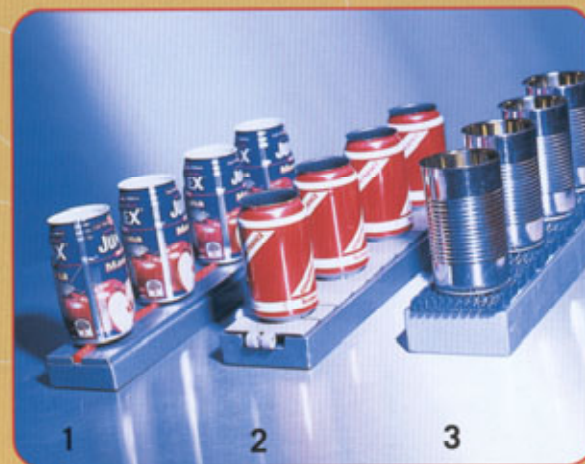

Ask for the special brochure on Magnetic Components from Walker-Hagou Magnetics

MAGNETIC SHEET SEPARATORS

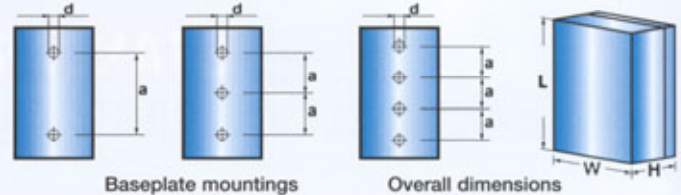

What does a Walker sheet separator do for you?

Walker sheet separators were especially developed to permit easy and uninterrupted removal of steel sheets stacked horizontally or vertically. No more prying apart of greasy or oily sheets.

Choosing the proper type of sheet separator

Selection of the best type and quantity is dependent upon the following factors:

- ◆ Stack height
- ◆ Flatness of the sheet
- ◆ Surface condition
- ◆ Thickness and dimensions of the sheets

For dry sheets the following can be applied

Sheet thickness up to:	0,7 mm	Cross section of the magnetic separator	73 x 28 mm
Sheet thickness up to:	1,0 mm	Cross section of the magnetic separator	103 x 28 mm
Sheet thickness up to:	2,0 mm	Cross section of the magnetic separator	104 x 49 mm
Sheet thickness up to:	3,0 mm	Cross section of the magnetic separator	155 x 47 mm
Sheet thickness up to:	4,0 mm	Cross section of the magnetic separator	179 x 88 mm
Sheet thickness up to:	6,0 mm	Cross section of the magnetic separator	279 x 94 mm



Sheet separator for thin sheets up to 0,25 mm.

Made for automatic steel sheet feeders, avoiding double sheet feeding. Code no: 92 99 003.

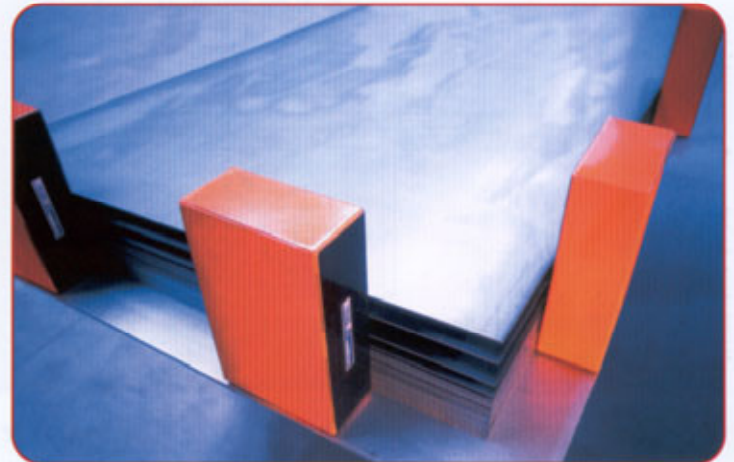

Advantage of the Walker sheet separators

Cut used of compressed air

Payback time in weeks

Stable magnet pack

No reduction in magnetic holding

No special precautions for storage

Stainless steel cover

Robust construction (no cast parts)

Great separating power

coupled with slender dimensions

Large assortment

Very simple mounting

Code	Sizes in mm			Threaded holes	
	L	W	H	center distance a	number x d
92.07.073	75	73	28	50	2 x M8
92.26.073	275	73	28	200	2 x M8
92.35.073	342	73	28	250	2 x M8
92.10.103	104	103	28	50	2 x M8
92.20.103	208	103	28	100	2 x M8
92.30.103	308	103	28	200	2 x M8
92.35.103	342	103	28	250	2 x M8
92.13.105	143	104	49	100	2 x M8
92.20.105	210	104	49	100	2 x M8
92.26.105	277	104	49	200	2 x M8
92.30.105	310	104	49	200	2 x M8
92.35.105	344	104	49	250	2 x M8
92.40.105	411	104	49	150	3 x M8
92.45.105	444	104	49	150	3 x M8
92.50.105	511	104	49	200	3 x M8
92.60.105	612	104	49	150	4 x M8
92.75.105	746	104	49	200	4 x M8
92.10.155	104	155	47	50	2 x M8
92.13.155	143	155	47	100	2 x M8
92.20.155	210	155	47	150	2 x M8
92.26.155	277	155	47	200	2 x M8
92.30.155	310	155	47	200	2 x M8
92.40.155	411	155	47	150	3 x M8
92.45.155	444	155	47	250	3 x M8
92.50.155	511	155	47	200	3 x M8
92.26.189	277	179	88	200	2 x M12
92.40.189	400	179	88	150	3 x M12
92.33.289	344	279	94	100	3 x M12
92.53.289	545	279	94	150	4 x M12
92.60.289	612	279	94	150	4 x M12
92.80.289	813	279	94	200	4 x M12

STANDARD CONVEYING SYSTEMS

ELEVATORS / LOWERATORS

Straight Conveyor

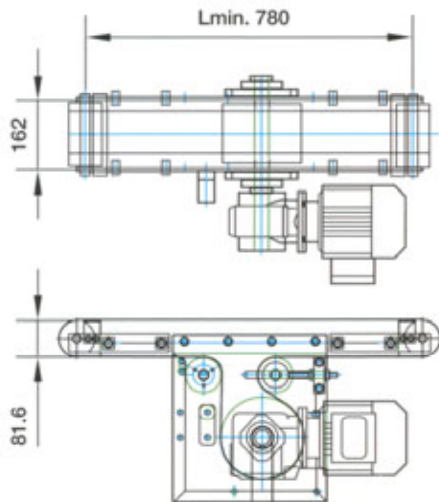

Elevator / Lowerator

Especially for empty and light weight filled cans
 Standard magnetic roller $\varnothing 220 \times 110$ mm.
 Standard motor SEW type SA....
 Mechanical belt tensioner
 Standard without supports
 Execution - Mild steel/ painted alu.profile
 - Stainless steel

L-Elevator / Lowerator

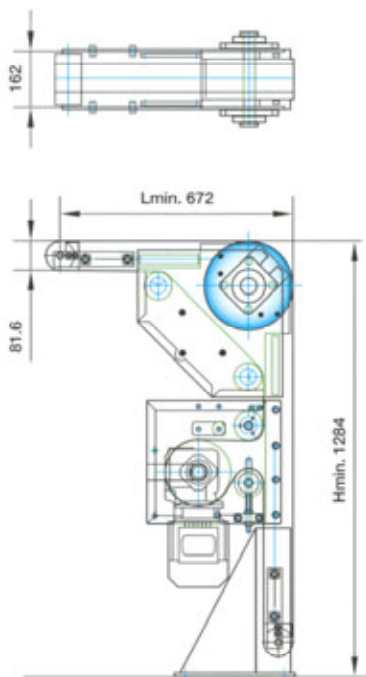

C-Elevator / Lowerator

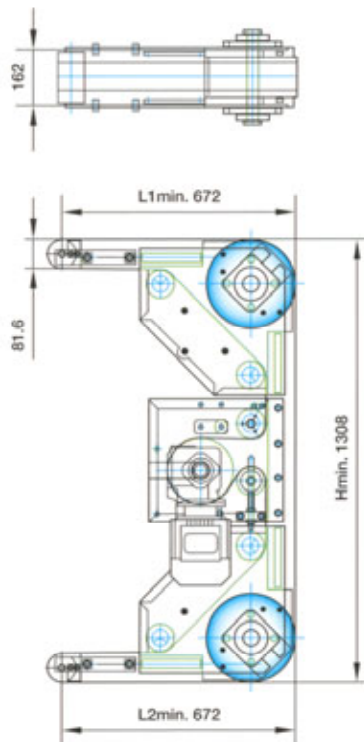

G-Elevator / Lowerator

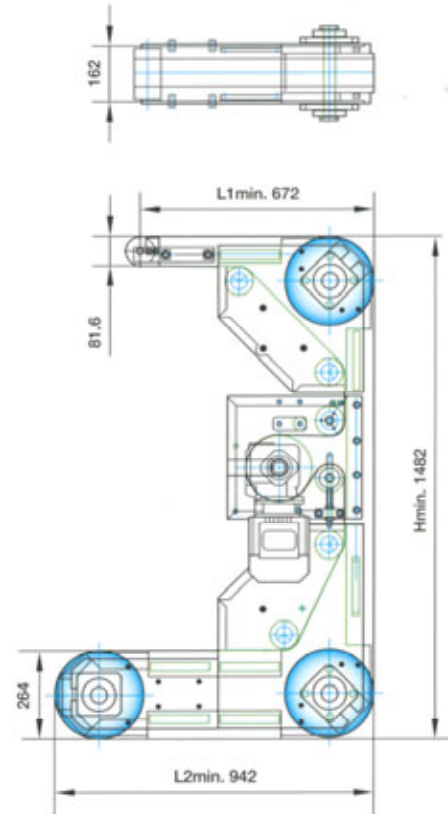

WIDE BELT CONVEYORS

MODULAIR "DO IT YOUR SELF" SYSTEM

Suitable for: Cans
Cartons
Bottles
Trays
Boxes
Crates

Important advantages of the system are:

- Low purchase price
- Low assembling cost
- Fast delivery
- Quick installation (no special tools needed.)
- Reliable design
- Versatility in layout
- Maintenance friendly

Standard widths:

- 400 mm 16"
- 600 mm 24"
- 900 MM 36"

For more information please ask for our special brochure

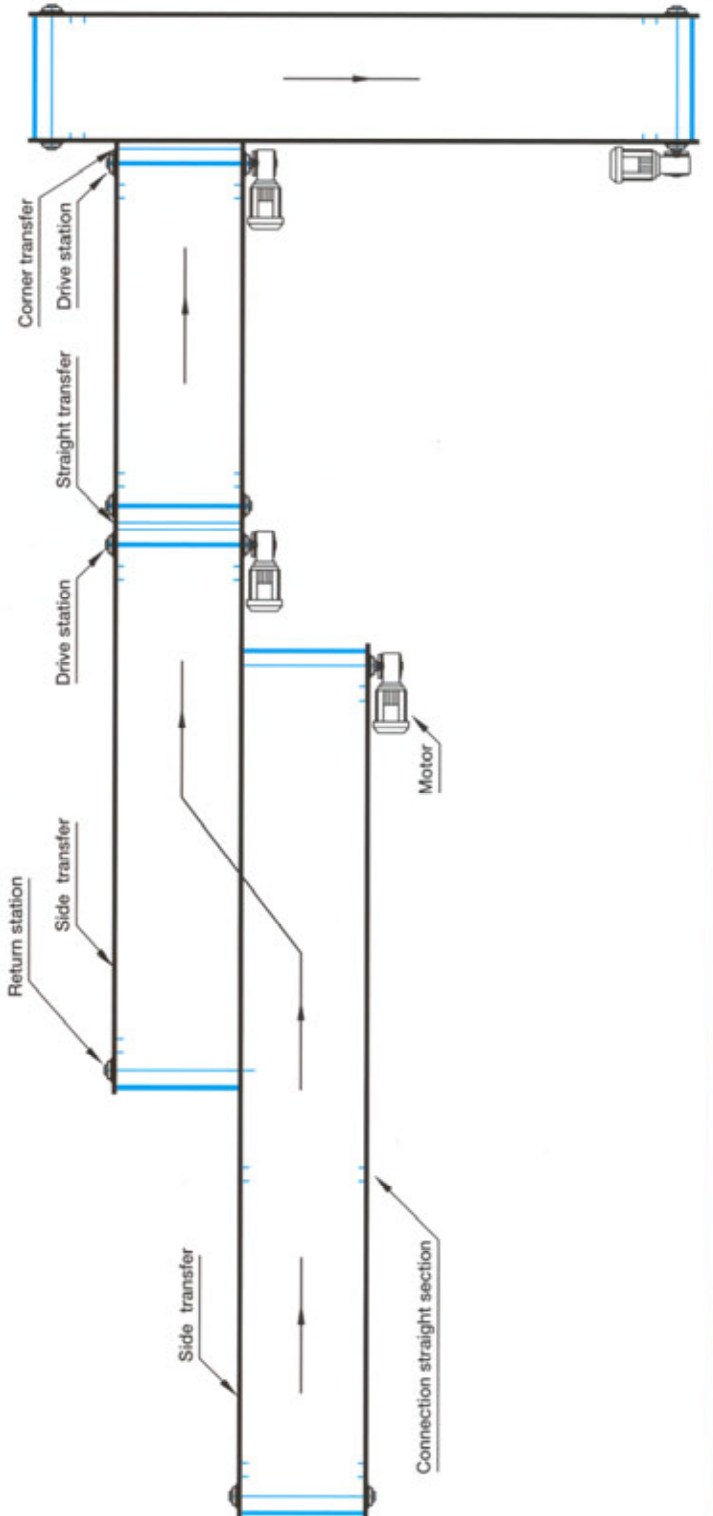

LINE CONTROL



How ever the high quality of your conveying equipment it is no guarantee of a successful line. Only when high quality userfriendly controls are included, the line will give you the efficiencies to beat your competitors. Walker-Hagou Magnetics control department when working in conjunction with our mechanical and magnetic designers can assure the controls suit the line requirements perfectly.

This combination also gives you other advantages such as:

- ◆ Only one partner to talk about your requirements and specifications.
- ◆ The delivered package is an integrated system from one source. Therefore no fingerpointing between several suppliers.

- ◆ Integral guarantee
- ◆ Integrated planning and realisation of:
 - Development resources
 - Manufacturing
 - Assembly
 - In house testing

By using the same synergy in the field a smooth quick installation is assured which reduces time and aggravation in commissioning.

SERVICE REPAIR

Over the last forty years that **Walker Hagou Magnetics** has been manufacturing conveying systems we have learnt a great deal about installation, service and repair. We have a department of highly specialized personnel to deal with routine servicing and to carry out repairs on broken or damaged equipment. Among this team is a group of people whose forte is in installation can conveying systems.

Conveying Systems

For Conveying Systems we offer not only an installation service for our own equipment but also a complete service for other manufactures equipment. In today's high speed production environment it is essential to keep all lines running at their best and even squeeze a little more out of them. To this end **Walker Hagou Magnetics** offers the following:

1. A line enhancement service where a conveying expert will visit your site, carry out a full survey and present a report of our recommendations. When a agreement is reached our service crew will carry out the work
2. An ongoing maintenance contract where **Walker Hagou Magnetics** personnel will visit your site at regular intervals to keep both the equipment we supplied and the line can handling conveying working at its optimum.
3. An annual shut down re-fit where a conveying expert will visit your site prior to the shut down and survey the lines or equipment in question, make a report and our service engineers would do the agreed work during the shut down period.
4. If you are contemplating relocating either a whole factory or just repositioning a line, **Walker Hagou Magnetics** can offer to provide line layout designs and supply engineers to carry out the work.

WALKER-HAGOU MAGNETICS PRODUCTS



END HANDLING SYSTEM



CAN OPENER



ELEVATOR / LOWERATOR

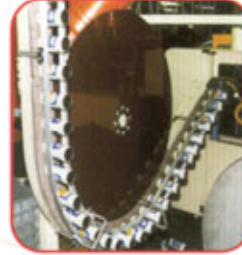

NECKER DISCHARGE



MAGNETIC MILLING TABLE



CAP / CROWN CORK ELEVATOR



SPRAY DISCHARGE



TWIST BELT



ROTOBUX HOLE CUTTING MACHINE



ROBOT HANDLING MAGNET



MASS CONVEYOR



END HANDLING



MASS ELEVATOR / LOWERATOR



COATER DISCHARGE



BI/DI DIVIDING TABLE



CHAIN CONVEYOR



DECOATER DISCHARGE



BELT ELEVATOR



CAN ELEVATOR



BATTERY LIFTING MAGNET

Since 1896

WALKER
100
A Century
of Leadership

Traditional Quality and High-Tech Innovation

GEHEUGENISRECHTEN INZAME ADVESBUREAU INCHOWEN 21.143.003. 2000.08. ALTERNATIONS RESERVEED 192.24.08



WALKER'S knowledge in conveying systems makes us the right partner to solve your conveying problems



WALKER HAGOU MAGNETICS

WALKER-HAGOU MAGNETICS B.V.
Industrieweg 9, 5531 AD Bladel
P.O.Box 35. 5530 AA Bladel
The Netherlands
Phone +31 (0) 497 38 38 35
Fax +31 (0) 497 38 20 06

Fax Especially Dep.Conveying Systems
+31 (0) 497 38 46 41

E-mail: whm@walkermagnet.com
www.walkermagnet.com/hagou



WALKER MAGNETICS UK

WALKER MAGNETICS UK LTD.
Units 4 & 5 Firbank Court
Firbank Way
Leighton Buzzard
Bedfordshire
LU7 8YJ
Phone (+44) 2 525 37 27 14
Fax (+44) 1 525 37 58 52
E-mail: wmuk@walkermagnet.com
www.walkermagnet.com

